

FIXTURES

// PLUMBING + ELECTRICAL

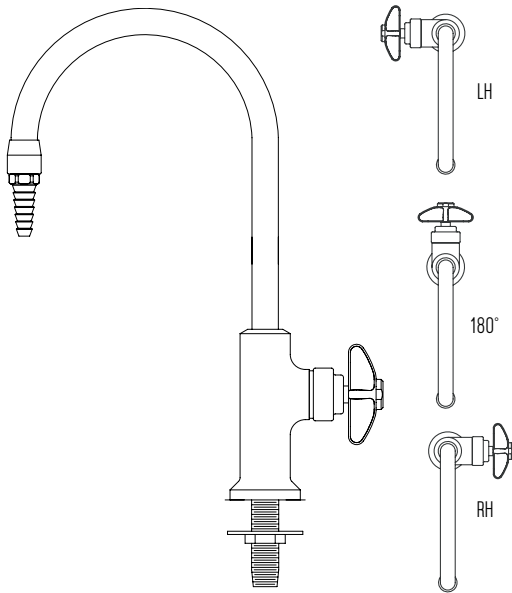

FEATURES

- + Polished chrome plated finish on fixtures standard
- + Pure tin interior lining on fixtures
- + Remote-operated fixtures come w/ four-prong handles
- + Baked, color-coded epoxy upper assemblies
- + Control rods cut to length
- + Pre-plumbed services // 3/8" Outer Diameter
- + Pre-plumbed services // 1/4" Inner Diameter
- + Polypropylene tubing for water, air and vacuum
- + Polypropylene tubing // 1/2" Outer Diameter
- + Flexible stainless steel tubing for burning gas services

90° WATER FAUCET

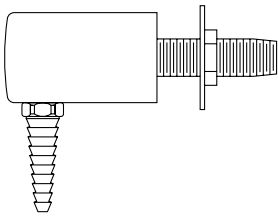

PRODUCT NUMBER

QS-FXTDS

GOOSENECK FAUCET

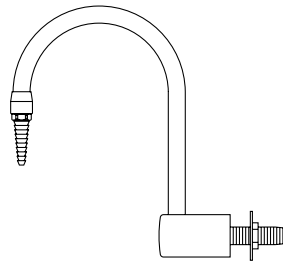

PRODUCT NUMBER

QS-FXTGN

// SPECIFY HOT OR COLD

DECK MOUNT WATER

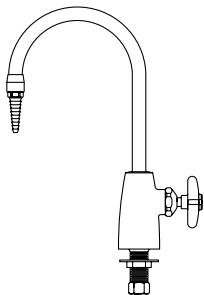

PRODUCT NUMBER

QS-FXDMW

HOT + COLD WATER MIXING

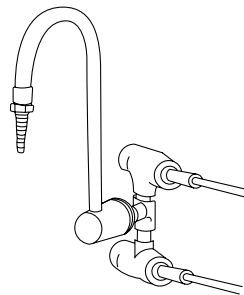

PRODUCT NUMBER

QS-FXTCWM

GOOSENECK FAUCET W/ VACUUM BREAKER

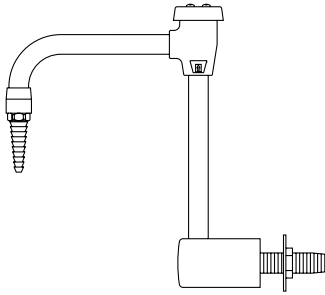

PRODUCT NUMBER
QS-FXTGNWVB
// SPECIFY HOT OR COLD

HOT + COLD WATER MIXING

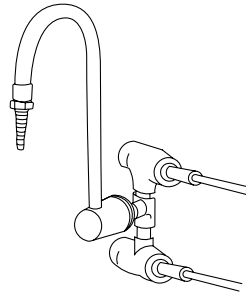

PRODUCT NUMBER
QS-FXTCWM

REMOTE CONTROL FIXTURES

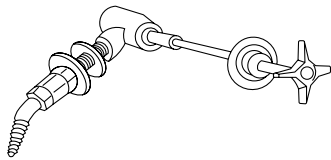

PRODUCT NUMBER
QS-FXTGNWVB
// SPECIFY HOT OR COLD

DECK MOUNT GAS DOUBLE OUTLET

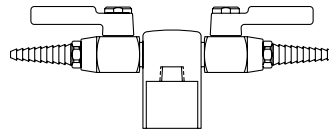

PRODUCT NUMBER
QS-FXTDMG2
// SINGLE ALSO AVAILABLE

EXPLOSION PROOF LIGHT

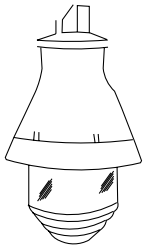

PRODUCT NUMBER	TYPE
QS-XPL	Class 1 / Group 1
// INCANDESCENT OR FLUORESCENT	

GROUND FAULT INTERRUPTER DUPLEX

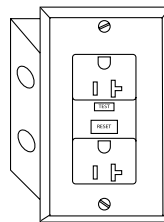

PRODUCT NUMBER	TYPE
QS-GFI	120 Volt / 20 Amp
// STANDARD BLACK OUTLET W/ COVER	

EXPLOSION PROOF OUTLET

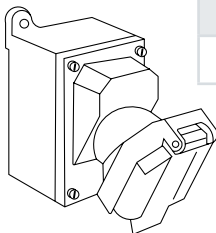

PRODUCT NUMBER	TYPE
QS-XPO	Class 1 / Group 1

EXPLOSION PROOF SWITCH

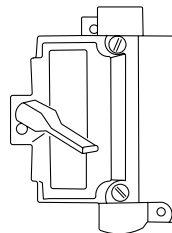

PRODUCT NUMBER	TYPE
QS-XSW	Class 1 / Group 1

RED ILLUMINATED TOGGLE SWITCH

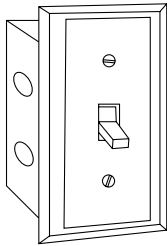

PRODUCT NUMBER
QS-BLSW
// STANDARD BLACK W/ COVER PLATE

SINGLE POLE RECEPTACLE / 230, 277

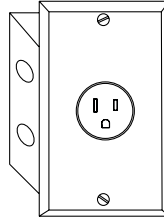

PRODUCT NUMBER	TYPE
QS-208	208 Volt / 20 Amp
// OTHER AVAILABLE UPON REQUEST	

SINGLE POLE SWITCH

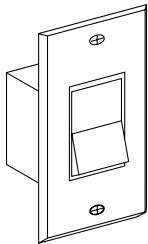

PRODUCT NUMBER	TYPE
QS-LTSW	15 Amp
// STANDARD BLACK W/ COVER PLATE	

NOTE // If a fume hood is not pre-wired, wiring in the field must be performed using U.L. listed electrical fixtures while observing NEC standards and local electrical codes. Pre-wire service is completed in accordance with NEC and U.L. 1805 standards.

PRODUCT NUMBER	TYPE
FXTGAS	Gas
FXTAIR	Air
FXTVAC	Vacuum
FXTNIT	Nitrogen
FXTCW	Cold Water
// OTHER AVAILABLE UPON REQUEST	

